

prepFAST X, prepFAST MX, prepFAST MAX

Syringe Driven Sample Introduction for ICP/ICPMS

Autodilution

Autocalibration

Automated Sample Sensing

Autocorrecting Autosampler

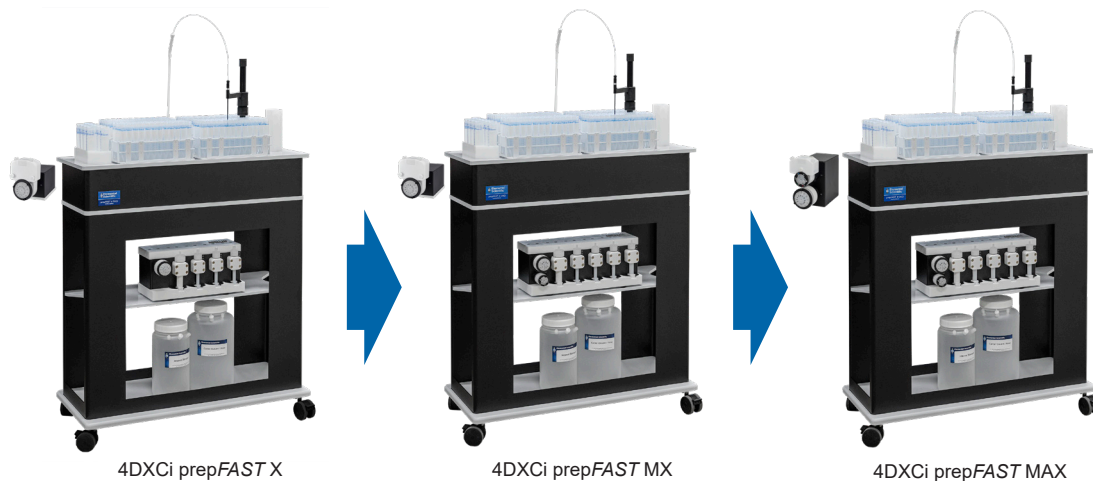

Fully Automated Sampling with Inline Dilution

prepFAST inline dilution systems fully automate the ICP and ICPMS analysis process. Preparation of calibration standards, dilution of samples, addition of internal standards, and automated SampleSense FAST sample loading are combined along with the unique DXCi autocorrecting autosampler for the complete automation solution for trace metal analysis.

The prepFAST X systems are a new generation of automated inline dilution models that have been enhanced to offer more intelligent operation, higher speed, and improved performance. Designed for all applications up to 40,000-fold dilution, three prepFAST X models are available.

prepFAST Fully Automates Daily Lab Functions for ICP and ICPMS Analysis

- Provides fully automated inline calibration
- Automatically dilutes samples inline
- Reduces new operator training
- Reduces sample consumption & waste
- Improves laboratory productivity



4DXCi prepFAST X

prepFAST automatically dilutes samples right at the moment of analysis



Intelligent DXCi autocorrecting autosampler



High throughput SampleSense FAST valve

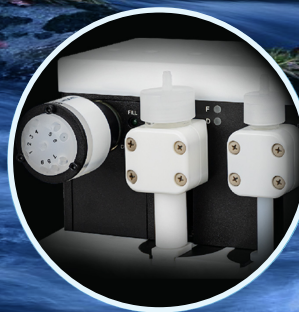

Accurate automated inline syringe dilution

prepFAST with SampleSense

prepFAST X

- Autocalibration, autodilution, and auto overrange dilution
- SampleSense automated vacuum sample loading
- Syringe-driven internal standard addition
- Improved washout and high throughput
- Autocorrecting DXCi autosampler available in 2, 4, 8, and 14 rack capacities
- **Dilution range 1-400x**

prepFAST MX

All features of prepFAST X plus:

- Precision syringe sample loading for viscous and small sample volumes
- Enhanced syringe washout performance
- **Dilution range 1-400x**

prepFAST MAX

All features of prepFAST MX plus:

- Dual Stage Dilution
- **Dilution range 1-40,000x**

prepFAST X Systems Comparison

	prepFAST X	prepFAST MX	prepFAST MAX
SampleSense	✓	✓	✓
Autocalibration	✓	✓	✓
Autodilution	✓	✓	✓
Auto Overage Dilution	✓	✓	✓
Syringe-driven Internal Standard	✓	✓	✓
High Speed Rinse Ultimate Washout		✓	✓
Micro-volume Sample Analysis		✓	✓
Volatile Organic Solvent Analysis		✓	✓
Dual Stage Dilution			✓
Dilution Range	1-400x	1-400x	1-40,000x

Automated Sample Sensing – SampleSense

Optical sensors in the SampleSense valve monitor the sample arrival in the valve – automating the sample loading process.

- **Innovative Sample Loading**
 - SampleSense accounts for viscosity and automatically adjusts timing. One valve, one loop and one method for multiple sample types.
- **Sample Savings**
 - The sample is injected at precisely the right time. Every time. Even for small samples.
- **Time Savings**
 - Operator time for sample introduction method development is eliminated. Just run samples.
- **Error Notification**
 - Incomplete sample loading or bubbles in the sample are detected and logged.

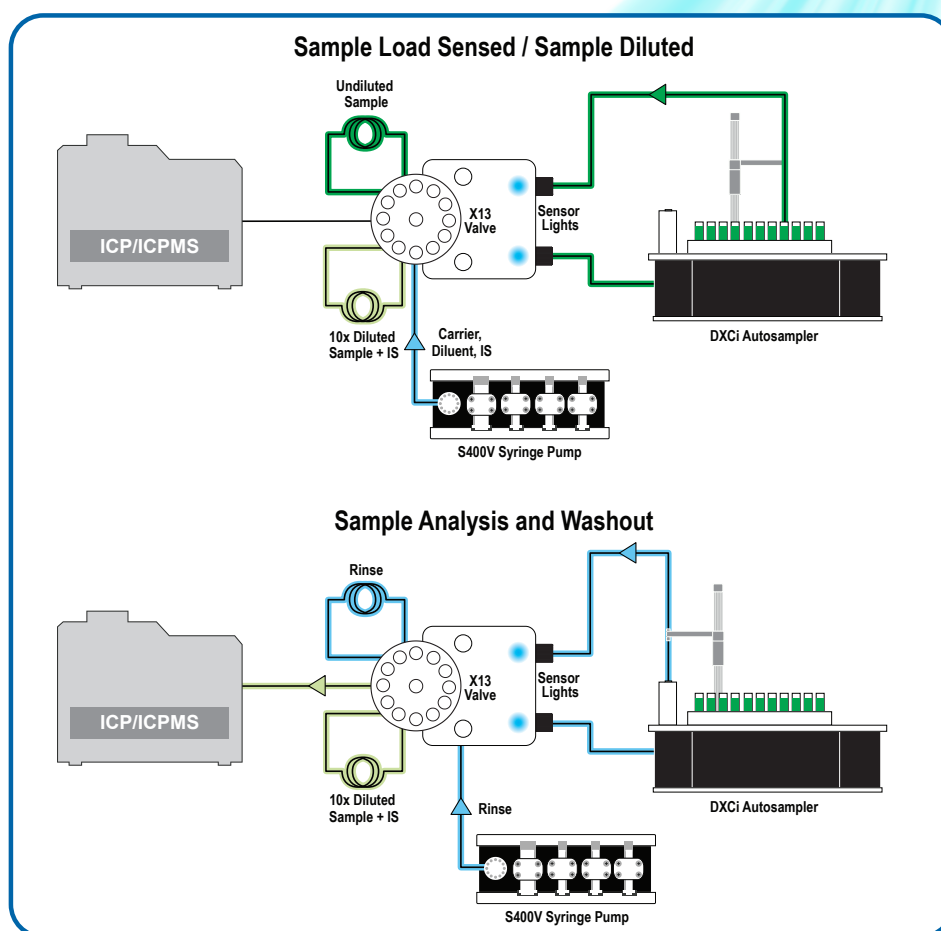

Autocalibration

Automates inline preparation of ICP/ICPMS calibration standards

- Save time and improve laboratory efficiency by eliminating labor-intensive standard preparation
- Prepare from single or multiple stock standards
- Improve calibration linearity and minimize contamination
- Reduce laboratory waste and cleaning of labware

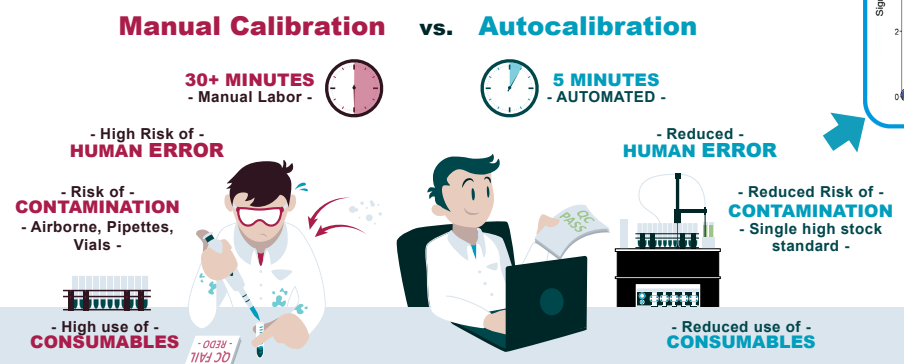
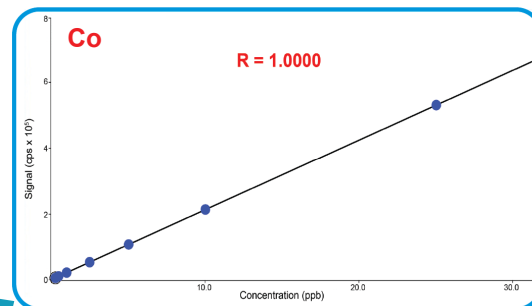

You make one standard – prepFAST makes the rest

Autodilution

prepFAST dilutes samples right at the moment of analysis

- Dilutes all samples by same factor, or on sample-by-sample basis
- Improves precision & accuracy by eliminating manual procedures
- Reduces vial and reagent usage
- Improves sample throughput & washout with FAST technology
- Reduces required training and experience for operators

Dilutes and reanalyzes out-of-range samples

- Autodilutes & re-runs when concentrations exceed calibration range
- Autodilutes & re-runs when Internal Standard is outside of limits*
- Generate reportable results for all samples in the initial run
- Eliminate operator intervention otherwise required

*Dependent on capabilities of instrument software utilized

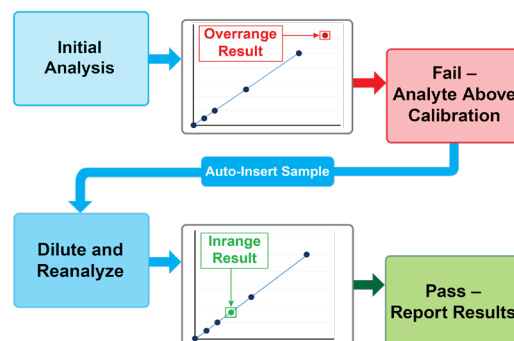

Features Diagram

prepFAST X /MX /MAX

AutoAlign Arm

- Self-realigns after encountering capped sample tube
- Metal-free fluoropolymer probe aligner

Sample Containers

- Flexible rack configurations
- Sample from micro vials to large bottles

Position Autocorrection

- Automatically goes to the correct position every time
- Automatically retries position if an obstacle is encountered

Highest Speed of Operation

- Corrects for stall events, even after years of use
- Keep analysis running, even after obstruction

High Performance Syringes

- Autocalibration and sample dilution
- Internal standard addition
- Rinsing/Washing
- Four syringe S400V (prepFAST X)
- Five syringe S500V2 (prepFAST MX & MAX)

Large Volume Reagent Bottles

Parabolic Probe

- Robust, heavy-walled, self-supporting

Optional Vented Enclosure

- ULPA filter option

Dual Overflowing Rinse Stations

- Ultra-low cross-contamination
- Optional organic solvent rinse
- Independently pumped for low rinse consumption

Vacuum Pump

- High-speed vacuum sample loading
- Rapid rinsing & cleaning

Syringe Sample Loading

- Precise sample loading for small samples or organic solvents (prepFAST MX & MAX)

SampleSense Valve Module

- Automatic optically-sensed sample loading
- Single valve 400x dilution range (prepFAST X & MX)
- Dual-stage 40,000x dilution range (prepFAST MAX)

prepFAST X Automated Inline Dilution

- Automatically dilutes calibration standards, overrange samples, and internal standard out-of-range samples without operator intervention
- Automated dilutions performed in same analysis as original samples, improving workflow

[See the prepFAST X in action](#) →

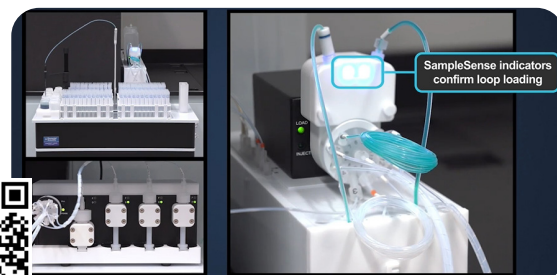

prepFAST X equipped with DXCi Autosampler

- DXCi autocorrecting autosampler intelligently autocorrects probe position, even if accidentally obstructed
- Parabolic probe design eliminates line kinking
- Available in 4 capacity sizes to fit lab requirements.
 - 2DXCi, 4DXCi, 8DXCi, 14DXCi

[See the DXCi in action](#) →

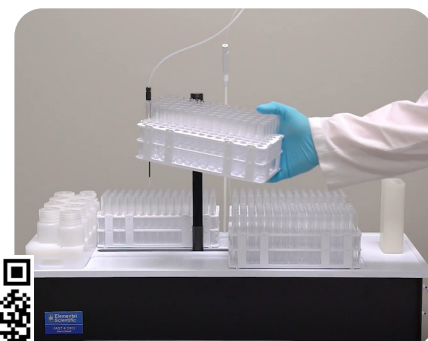

Model Selection Guide

Model	Features	Benefits
prepFAST X	SampleSense FAST high-speed vacuum sample loading	<ul style="list-style-type: none"> Actively monitors & optimizes each sample uptake Adjusts for varying sample viscosities & eliminates method timings Minimizes sample consumption Logs sample loading issues Single FAST valve design speeds washout & simplifies operation
	Autocalibration from single or multiple standards	<ul style="list-style-type: none"> Saves time & eliminates labor-intensive standard preparation Improves calibration linearity & minimize contamination Reduces lab waste & cleaning of labware
	Autodilution and overrange sample dilution	<ul style="list-style-type: none"> Automatically inline dilutes samples at the time of analysis Saves sample preparation time & reduces labware/reagent usage Generates reportable results for out-of-range samples Reduces operator intervention & training requirements
	Syringe-driven internal standard addition	<ul style="list-style-type: none"> Eliminates manual addition & imprecise peripump introduction
	DXCi Autocorrecting Autosampler	<ul style="list-style-type: none"> Probe arm automatically re-aligns after accidental obstruction Fastest probe speed & accuracy for microplates/small vessels Available autosampler capacities: 2DXCi, 4DXCi, 8DXCi, 14DXCi
	Fully automated sample introduction system	<ul style="list-style-type: none"> Customized valve mounting for all major ICP/ICPMS systems Rapid return on investment from reduced labor, increased sample throughput & enhanced performance Dilution range 1-400x
prepFAST MX	<p>All the capabilities of the prepFAST X plus:</p> <p>Precision syringe sample loading</p>	<ul style="list-style-type: none"> Supports viscous and small sample volumes Optimal for organic solvent samples Enhanced syringe washout of sample uptake pathway Dilution range 1-400x
prepFAST MAX	<p>All the capabilities of the prepFAST MX plus:</p> <p>Dual stage dilution</p>	<ul style="list-style-type: none"> Enhanced dilution capacity for higher sample concentration Dilution range 1-40,000x



© Elemental Scientific | 7277 World Communications Drive | Omaha, NE 68122
Tel: 1-402-991-7800 | sales@icpms.com | www.icpms.com

B-21219-6